

SAFETY & WARNINGS

1. Install in accordance with national and local electrical code regulations.
2. This product is intended to be installed and serviced by a qualified, licensed electrician.
3. Do not modify product beyond instructions or warranty will be void.
4. Do not submerge, nor install within 5 feet of a swimming pool.
5. Only install with a compatible Listed Class 2 DC LED driver.
6. Do not exceed maximum run recommended for Tape Light.
7. Failure to follow safety warnings, and installation instructions will void the warranty.

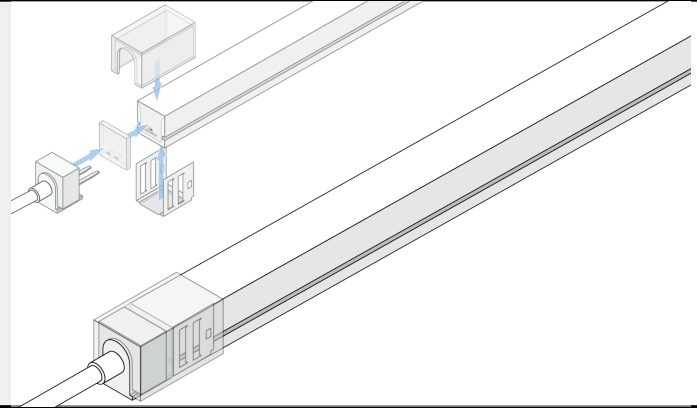

WARNING

DO NOT CONNECT DIRECTLY TO LINE VOLTAGE POWER!
Read all warnings and Installation instructions thoroughly.

HANDLE WITH CARE

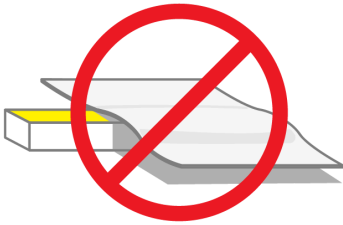

Do not cover with any materials.

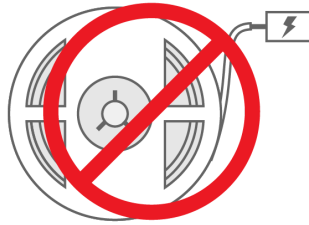

Do not power while attached to spool or tightly coiled.

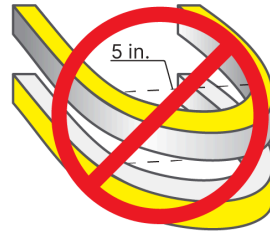

Do not bend to a diameter less than 5 inches.

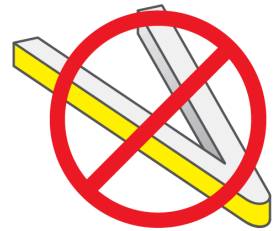

Do not fold, crease, or twist.

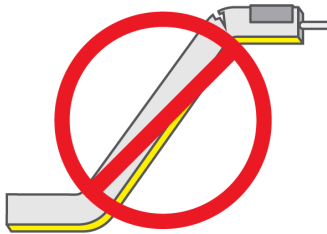

Do not allow product hang unsupported during installation.

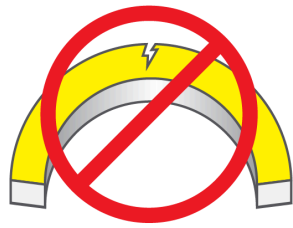

Top Bend: Do not bend on a horizontal plane.

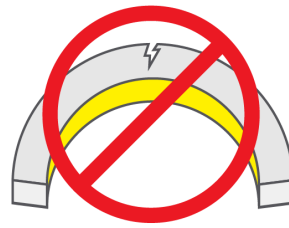

Side Bend: Do not bend on a vertical plane.

0. Field Assembly

Assembling this product in the field has a maximum rating of IP65. We suggest the use of our Factory Assembly (IP67) program when installed in a wet location environment.

1. Turn Power Off at Circuit Breaker

Never cut product attached to a live circuit. Do not exceed Class 2 Limit.

2. Cut CURVA™ to length

CURVA™ may be cut anywhere along its length. Ensure a flat, straight cut. Ensure polarity matches installation after cutting.

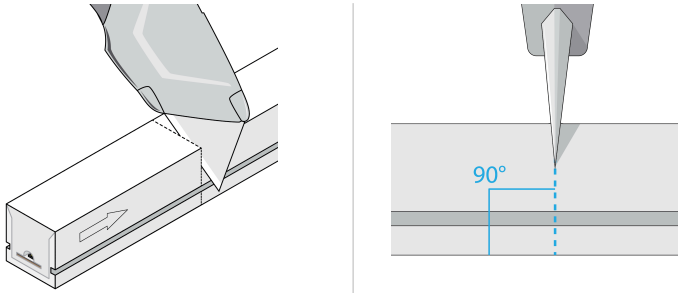

3. Attach Connector Clip

Slide connector clip over end of CURVA™, securing clip by pressing sides inward with front tabs flush against face of cut. Avoid tearing the jacket with clip teeth.

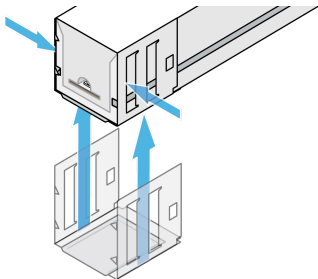

4. Glue Frosted Gasket to Connector

Apply Permatex® 80050 adhesive to both sides of frosted gasket, then slide gasket over metal blades against connector.

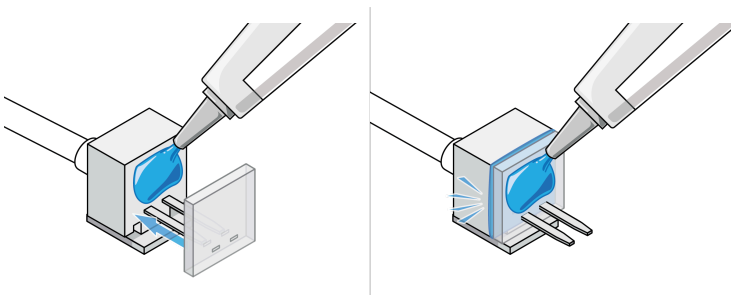

5. Attach Connector to CURVA™

5.1 - Open Space for Connector Blades

Locate plastic backing underneath LED strip light. Slide flathead screwdriver between LED strip light and backing to create space for connector blades.

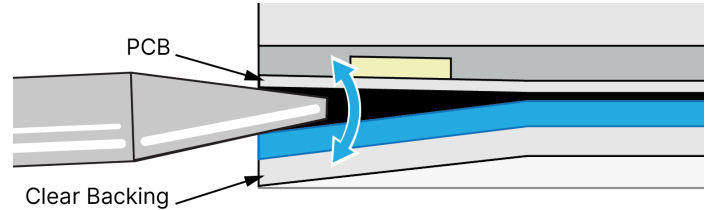

5.2 - Insert Connector

Pressing firmly, slide blades of connector directly under LED strip light above plastic backing.

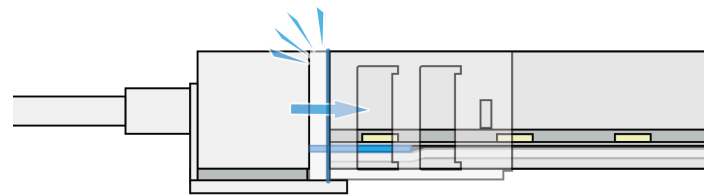

6. Attach Connector Cover

Slide clear plastic cover over connector until each side clicks into place.

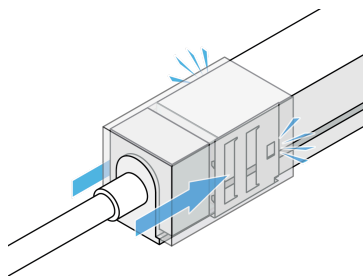

7. Attach End Cap

7.1 - Attach Connector Clip to CURVA™

Slide connector clip over end of CURVA™, securing clip by pressing sides inward with front tabs flush against face of cut. Avoid tearing the jacket with clip teeth.

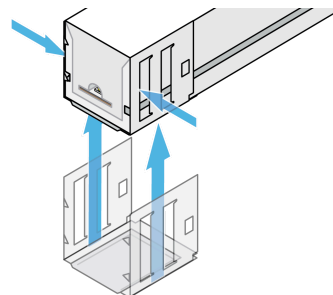

7.2 - Glue Gasket to End Cap

Using flathead screwdriver, remove gasket from end cap.

Apply Permatex® 80050 adhesive inside end cap.

Insert gasket into end cap.

Apply Permatex® 80050 adhesive over gasket.

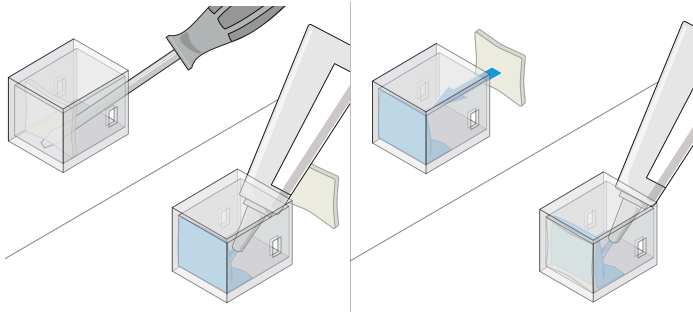

7.3 - Fasten End Cap to CURVA™

Slide end cap over end of connector clip until each side clicks into place.

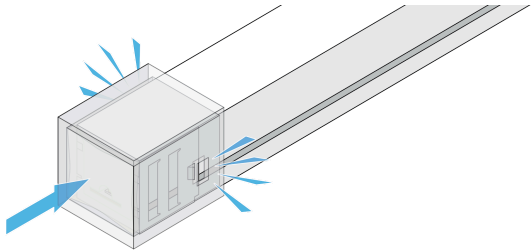

8. Test Connection

Power up CURVA™ to confirm functionality prior to mounting. Move power cord back and forth gently to test connection.

System Diagrams

Mount using included mounting clips/channels/screws.

The following diagram is an example system design. For information regarding larger systems or systems not pictured below, please see our web page or contact technical support. Always review each component installation guide for detailed and up-to-date wiring instructions. Install in accordance with national and local electrical codes.

Other diagrams will vary based on power and dimming requirements.

Standard Dimmer System Diagram

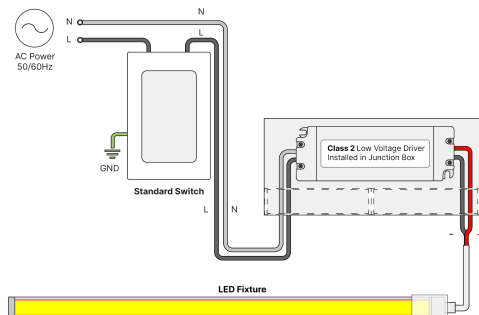

9A. Mounting (Channel)

Fasten channel to surface using mounting screws, then press CURVA™ into channel keeping connector flush with channel end. If factory assembled the entire luminaire will fit within channel.

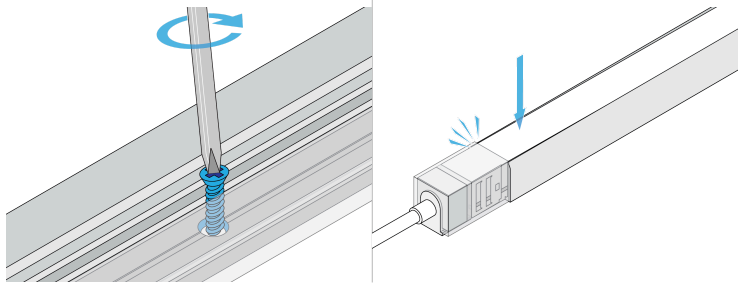

9B. Mounting (Bottom U-Clip)

At least every 6 inches, fasten bottom u-clips to surface using mounting screws, then press CURVA™ into bottom u-clip.

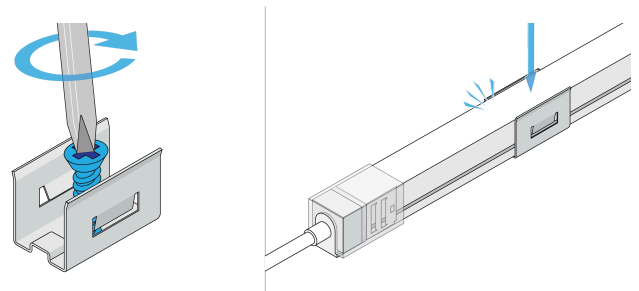

9C. Mounting (Spine Channel)

Fasten spine channel to surface using mounting screws, then press CURVA™ into channel keeping connector flush with spine channel end. If factory assembled the entire luminaire will fit within spine channel.

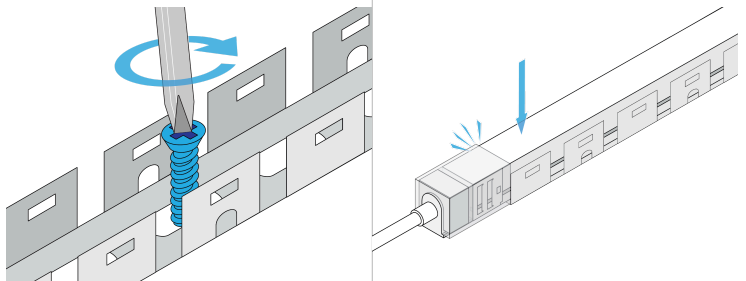

9D. Mounting (Top U-Clip)

Place CURVA™ in desired location, place top u-clip over CURVA™ at least every 6 inches, fasten top u-clips to surface using mounting screws.

